

TOSCA D61 - TOSCA PLUS D65

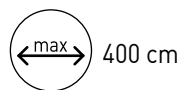

COLORI STANDARD - STANDARD COLORS

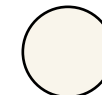

9010



TOSCA D61

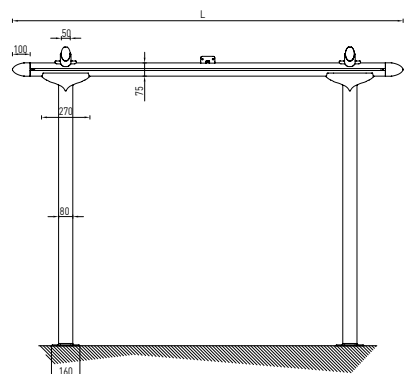

Vista frontale
Frontal view

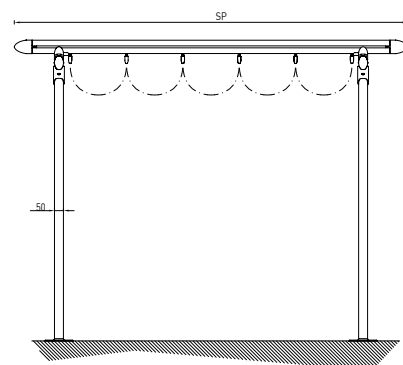

Vista laterale
Lateral view



TOSCA PLUS D65

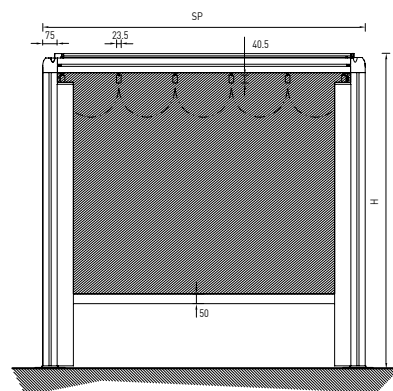

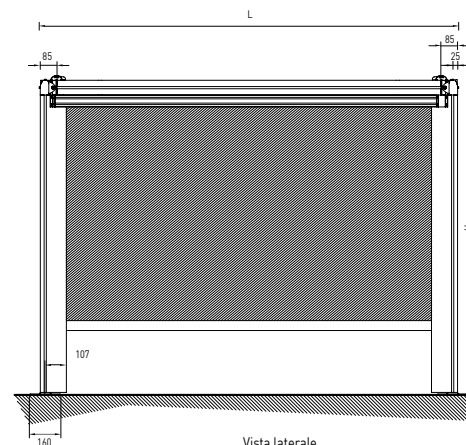

Vista frontale
Frontal view





Vista laterale
Lateral view

L= larghezza
width
S= sporgenza
projection

 Strutture per la copertura di terrazzi o aree di giardino.
Resistenza al vento garantita fino alla classe 2 secondo la UNI EN PR 13561.

 Structures for terraces or garden
Wind resistance guarantee up to class 2 according UNI EN PR 13561

 "Strukturen zur Abdeckung von Terrassen oder Grünflächen.
Windbeständigkeit garantiert bis Klasse 2 nach UNI EN PR 13561.

 Strutture per la copertura di terrazzi o aree di giardino.
Resistenza al vento garantita fino alla classe 2 secondo la UNI EN PR 13561.

 Estructura para la cobertura de la terraza o zonas de jardín.
Resistencia al viento garantizada hasta la clase 2 según la UNI EN PR 13561.