





**Struttura con tenuta all'acqua.**

Waterproof structure.  
Wasserdichte Anlage.  
Structure étanche à l'eau.  
Estructura hermética al agua.



**Carico su copertura: minimo 80kg/mq.**

Coverage loading: minimum 80 kg/m2.  
Traglast auf der Abdeckung min 80 Kg/Qm.  
Charge de la couverture: minimum 80kg/m2.  
Carga sobre cubierta: mínimo 80 kg/ mq.



**Possibilità di automatizzare la movimentazione delle lame attraverso l'utilizzo dei sensori vento e pioggia.**

Possibility of automatize the movement of the blades through wind and rain sensors.  
Es ist moeglich die Lamellen automatisch durch Wind und Regenwaechter zu bewegen.  
Possibilité d'automatiser le mouvement des lames avec l'utilisation des senseurs vent et pluie.  
Posibilidad de automatizar el movimiento de las lamas a través del uso de los sensores de viento y lluvia.





**Motori compatibili con la tecnologia SOMFY RTS e TAHOMA.**

Motors compatible with Somfy RTS and Tahoma technologies.  
Die Motoren sind kompatibel mit der SOMFY Technologie RTS und TAHOMA.  
Moteurs compatibles avec la technologie SOMFY RTS et TAHOMA.  
Motores compatibles con la tecnología SOMFY RTS e TAHOMA.



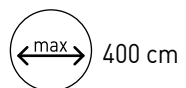
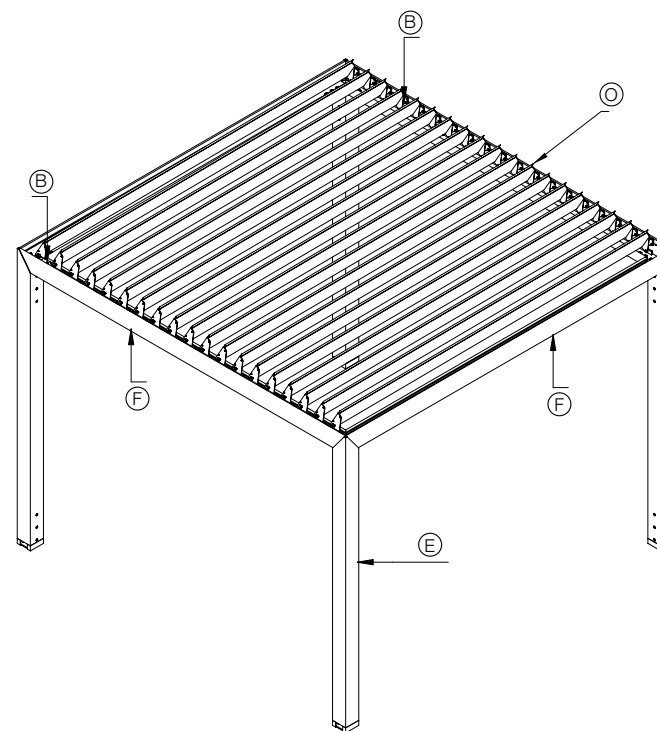
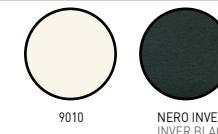





**COLORI STANDARD — STANDARD COLORS**

 **Struttura ombreggiante autoportante in alluminio con tetto a lame orientabili composta da un profilo grondaia perimetrale che permette la rotazione delle lame e lo scarico dell'acqua. La movimentazione avviene attraverso l'utilizzo di motori lineari. Resistenza al vento garantita fino alla classe 6 secondo la UNI EN 13561.**

 **Solar shading aluminium free-standing structure with roof in adjustable louvre blade system consisting of a perimetral gutter which permits the louvre blade system movement and the water discharge. Movement done by linear motors. Wind resistance guarantee up to class 6 according to UNI EN 13561.**

 **Schattenspendende selbststehende Strukturen mit verstellbaren Dachlamellen aus Aluminium. Bestehend aus Rinnenprofilen, die die Drehung der Lamellen und den Wasserablauf ermöglichen. Die Bewegung erfolgt durch den Einsatz von Linearmotoren. Die Windbeständigkeit ist bis Klasse 6 nach UNI EN 13561 garantiert.**

 **Structure autoportante en aluminium, avec toiture à lames orientables. Elle est composée d'une gouttière périmétrale assurant une étanchéité optimale. Le mouvement se fait grâce à des moteurs linéaires. Résistance au vent est garantie en classe 6 selon la UNI EN 13561.**

 **Estructura sombreada autoportante en aluminio con techo de lamas orientables compuesta de un perfil canalón perimetral que permite la rotación de las lamas y la descarga del agua. La movimentación funciona gracias a la utilización de un motor lineal. Resistencia al viento garantizada hasta la clase 6 según la UNI EN 13561.**

B Comando di movimentazione elettrico  
O Profilo lama  
F Trave frontale  
E Pilastro

B Moving electrical control  
O Louvre blade profile  
F Frontal girder  
E Pilar

B Elektrische Bedienung  
O Lamellenprofil  
F Frontbalken  
E Pfosten

B Commande pour le manoeuvre électrique  
O Profil lame  
F Poutre frontale  
E Pilier

B Mando de movimiento eléctrico  
O Perfil lama  
F Viga frontal  
E Pie



Schema tecnico generale/General technical plan/Allgemein -  
technisches Schema/Plan technique général/Dibujo tecnico general

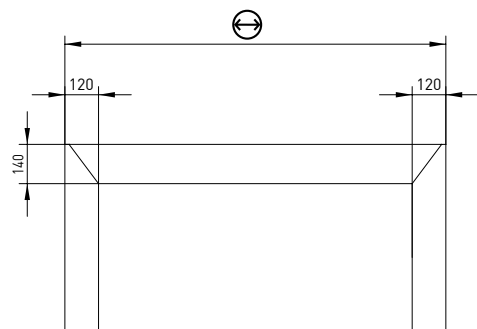
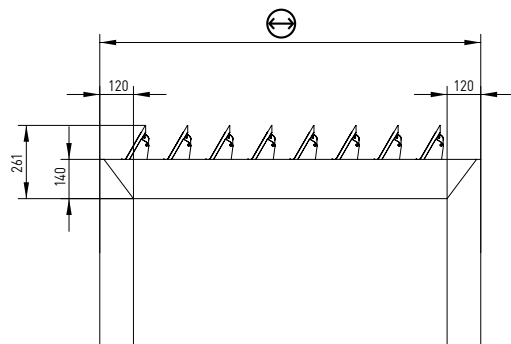

Sezione travi/Girder section/Balkenquerschnitt/Section poutres/Sección viga

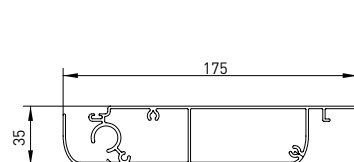

Profilo lama  
Louvre blade profile  
Lamellenprofil  
Profil lame  
Perfil lama

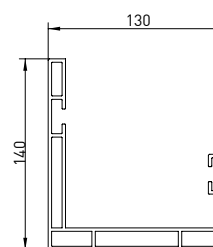

Grondaia  
Gutter  
Dachrinne  
Gouttière  
Alero

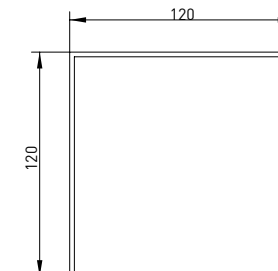

Pilastro  
Pilar  
Profil  
Pilier  
Pie



Attacchi a terra GENNIUS  
Gennius ground connection  
Gennius Bodenbefestigung  
Support fixation sol Gennius  
Sujeción a suelo Gennius

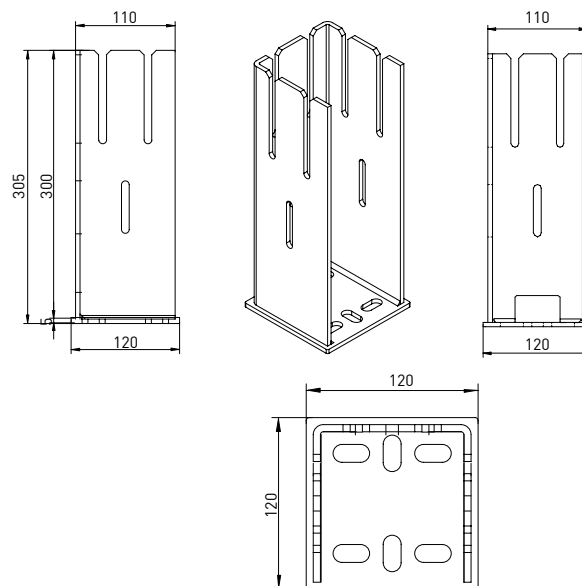

Piastra a terra per piedino  
Ground connection  
Fussbodenplatte  
Platine au sol pour pied  
Placa de suelo para cubre pie

